

# H5A Explosion-Protected PTZ Camera

2 MP

Avigilon H5A Explosion-Protected cameras are certified for explosion-rated environments according to international standards. They are designed to offer an efficient video security solution for hazardous environments that face the risk of explosions due to the presence of flammable gases or dust, including oil and gas, marine, industrial and food production sites.

The cameras feature exceptional imaging that works in conditions with poor lighting, and include next generation video analytics to offer enhanced object detection, tracking and classification.



## Features



### NEXT-GENERATION VIDEO ANALYTICS

Expanded object classifications and more accurate detection in crowded scenes so you can detect and act faster.



### EXPLOSION PROTECTION

Heavy-duty housing custom-built for H5A cameras.



### H.265 WITH HDSM SMARTCODEC<sup>TM</sup> TECHNOLOGY

Optimizes compression levels for regions in a scene to help maximize bandwidth savings, helping to keep internet connectivity costs down.



### AUTOMATIC IR CUT FILTER

Exceptional imaging performance in low-light situations.



### WIDE DYNAMIC RANGE

Capture details in scenes with both very bright and dark areas.



### LIGHTCATCHER<sup>TM</sup> TECHNOLOGY

Offers exceptional detail in areas with low lighting.



### ONVIF<sup>®</sup> COMPLIANT

Built on an open platform to allow integration with other security solutions.



### HIGH TEMPERATURE RANGE

Optimized to operate reliably even at increased temperature variances.

# Specifications

<b>IMAGE PERFORMANCE</b>	Resolution	2.0 MP		
	Image Sensor	1/2.8" progressive scan CMOS		
	Max Resolution (H × V) and Aspect Ratio	(16:9) 1920 × 1080		
	Dynamic Range	WDR Off	83 dB	
		WDR On	120 dB	
	Max Image Rate	60 fps		
3D Noise Reduction Filter	Yes			
<b>LENS</b>	Lens	4.3-129 mm (30x zoom)		
	Minimum Illumination	0.1 lux (F/1.6) in color mode; 0.03 lux (F/1.6) in monochrome mode		
	Horizontal Angle of View Based on Aspect Ratio	(16:9) 3.1°-64°		
	Vertical Angle of View Based on Aspect Ratio	(16:9) 1.7°-38°		
	Max Aperture	F1.6		
	Control	P-Iris, remote focus and zoom		
<b>IMAGE CONTROL</b>	Image Compression Method	H.264 HDSM SmartCodec, H.265 HDSM SmartCodec, Motion JPEG		
	Streaming	Multi-stream H.264, Multi-stream H.265, Motion JPEG		
	Motion Detection	Pixel motion: Selectable sensitivity and threshold	Classified object detection	
	Camera Tamper Detection	Yes, video analytics based		
	Electronic Shutter Control	Automatic, Manual (1/1 to 1/30,000 sec)		
	Iris Control	Automatic, Open, Closed		
	Day/Night Control	Automatic, Manual		
	Flicker Control	60 Hz, 50 Hz		
	White Balance	Automatic, Manual		
	Backlight Compensation	On/Off		
	Privacy Zones	3D, up to 64 zones		
	Presets	500 named presets		
	Tours	10 named tours		
	Digital Zoom	Up to 100x when used with ACC™ Client for Windows		
	Electronic Image Stabilization	On/Off		
Digital Defog	Adjustable/Off			
<b>NETWORK</b>	Network	10BASE-T/100BASE-TX, RJ45 Connector (CAT5E cabling), and SFP slot		
	ONVIF	ONVIF compliance version 1.02, 2.00, Profile S, Profile T ( <a href="http://www.onvif.org">www.onvif.org</a> )		
	Security	Password protection, HTTPS encryption, digest authentication, WS authentication, user access log, 802.1x port based authentication		
	Protocols	IPv6, IPv4, HTTP, HTTPS, SOAP, DNS, NTP, RTSP, RTCP, RTP, TCP, UDP, IGMP, ICMP, DHCP, Zeroconf, ARP		
	Streaming Protocols	RTP/UDP, RTP/UDP multicast, RTP/RTSP/TCP, RTP/RTSP/HTTP/TCP, RTP/RTSP/HTTPS/TCP, HTTP		
	Device Management Protocols	SNMP v2c, SNMP v3		
	<b>MECHANICAL</b>	Dimensions (LxWxH)	313 mm × 232 mm × 398 mm; 12.3" × 9.13" × 15.7"	
Weight		26.5 kg; 58.4 lbs		
Body		AISI 316L stainless steel		
Finish		Electro-polished surface		
Adjustment Range		Pan: 360° continuous, max 100°/s	Tilt: -90° to 90°, max 100°/s	
Wiper		Yes		
Cable Entry		2 × 3/4" NPT		
<b>ELECTRICAL</b>	Power Consumption	120 W		
	External Power	Ordering options:	230 VAC, 0.5 A, 50/60 Hz	
			24 VAC, 5 A, 50/60 Hz	
		120 VAC, 1 A, 50/60 Hz		
<b>ENVIRONMENTAL</b>	Operating Temperature	-40 °C to +55 °C (-40 °F to 131 °F), in enclosed space -40 °C to +60 °C (-40 °F to 140 °F), with ambient convection		
	Storage Temperature	-40 °C to +55 °C (-40 °F to 131 °F)		
	Humidity	10% - 95% non-condensing		
	Cold Start	Up to 2 hour startup delay at temperature lower than -10 °C (14 °F)		
	Wind Resistance	Pan and tilt operational at a maximum of 210 km/h wind (130.5 mph)		
<b>AUXILIARY I/O</b>	Input for Remote Reset	1		
	Alarm Inputs	1		
	Relay Outputs	1+1 (one relay reserved for washer pump and one configurable, 1A, 30 VAC/60 VDC max)		

CERTIFICATIONS		Certifications/Directives	UL, cUL, CE, RCM
		Safety	UL/CSA 62368-1, EN/IEC 62368-1
		Environmental	EN/IEC 60529: IP66, IP67, IP68, IP69 EN 60068-2-52: salt spray UL50E: 4X, 6P
		Electromagnetic Emissions	FCC Part 15 Subpart B Class A, IC ICES-003 Class A, EN 55032 Class A, EN 61000-6-4, EN 61000-3-2, EN 61000-3-3
		Electromagnetic Immunity	EN 50130-4
Explosion Protected	ATEX	EN 60079-0, EN 60079-1, EN 60079-31	
	IECEX	IEC 60079-0, IEC 60079-1, IEC 60079-31	
	EAC Ex	ГОСТ IEC 60079-0, ГОСТ IEC 60079-1, ГОСТ IEC 60079-31	
	INMETRO	ABNT NBR IEC 60079-0, ABNT NBR IEC 60079-1, ABNT NBR IEC 60079-31	
	KCS	Employment and Labor Department 2016-54	
	Haz Loc for USA	UL 60079-0, UL 60079-1, UL 60079-31	
	Haz Loc for Canada	CSA C22.2 No. 60079-0, CSA C22.2 No. 60079-1, CSA C22.2 No. 60079-31	

Camera certified by Videotec S.P.A., model MPX.

## Analytics Specifications

### SUPPORTED ANALYTICS EVENTS AT HOME POSITION

Objects in Area	The event is triggered when the selected object type moves into the region of interest.
Object Loitering	The event is triggered when the selected object type moves into the region of interest and then stays for an extended amount of time.
Objects Crossing Beam	The event is triggered when the specified number of objects have crossed the directional beam that is configured over the camera's field of view. The beam can be unidirectional or bidirectional.
Object Appears or Enters Area	The event is triggered by each object that enters the region of interest. This event can be used to count objects.
Object Not Present in Area	The event is triggered when no objects are present in the region of interest.
Objects Enter Area	The event is triggered when the specified number of objects have entered the region of interest.
Objects Leave Area	The event is triggered when the specified number of objects have left the region of interest.
Object Stops in Area	The event is triggered when an object moves into a region of interest and then stops moving for the specified threshold time.
Direction Violated	The event is triggered when an object moves in the prohibited direction of travel.
Tamper Detection	The event is triggered when the scene unexpectedly changes.

### SUPPORTED CLASSIFIED OBJECT TYPES

Object Types in Outdoor Mode	Vehicle, sub-types: Car, Truck, Bicycle, Motorcycle, Bus Person
Object Types in Indoor Mode	Person



### TEACH BY EXAMPLE

Teach By Example	Yes, when used with Avigilon Control Center™ software
------------------	---

### AVIGILON CONTROL CENTER (ACC) VERSIONS SUPPORTED FEATURES

ACC™ Version 6.14.10 or higher	All supported analytic events with two types of classified objects: person or vehicle. Appearance search when paired with appropriate server hardware. H.265 supported.
ACC Version 7.2 or higher	All supported analytic events with people and vehicles and all vehicle sub-types as classified objects. Appearance search when paired with appropriate server hardware. H.265 supported.

## Explosion-Protected Certifications

Certification	Marking	Ambient Temperature	Cable Entry Temperature
ATEX	 II 2 G Ex db IIC T6...T5 Gb  II 2 D Ex tb IIIC T85°C...T100°C Db	-40°C ≤ Ta ≤ 55°C or +70°C	80°C
IECEX	Ex db IIC T6...T5 Gb Ex tb IIIC T85°C...T100°C Db	-40°C ≤ Ta ≤ 55°C or +70°C	80°C
EAC Ex	1 Ex d IIC T6...T5 Gb X Ex tb IIIC T85°C...T100°C Db X	-40°C ≤ Ta ≤ 55°C or +70°C	80°C
INMETRO	Ex db IIC T6...T5 Gb Ex tb IIIC T85°C...T100°C Db	-40°C ≤ Ta ≤ 55°C or +70°C	80°C
KCs	Ex d IIC T6...T5 Ex tb IIIC T85°C...T100°C	-40°C ≤ Ta ≤ 55°C or +70°C	80°C
Hazardous Location America (All versions)	Class 1, Zone 1, AEx db IIC T6...T5 Zone 21, AEx tb IIIC T85°C...T100°C Db Class I, Div 2, Group A, B, C, and D, T6...T5 Class II, Div 2, Group F and G, T6...T5	-40°C ≤ Ta ≤ 55°C or +70°C	80°C with Ta = 69°C 81°C with Ta = 70°C
Hazardous Location Canada (All versions)	Ex db IIC T6...T5 Gb X Ex tb IIIC T85°C...T100°C Db X Class I, Div 2, Group A, B, C, and D, T6...T5 Class II, Div 2, Group F and G, T6...T5	-40°C ≤ Ta ≤ 55°C or +70°C	80°C with Ta = 69°C 81°C with Ta = 70°C

# Outline Dimensions

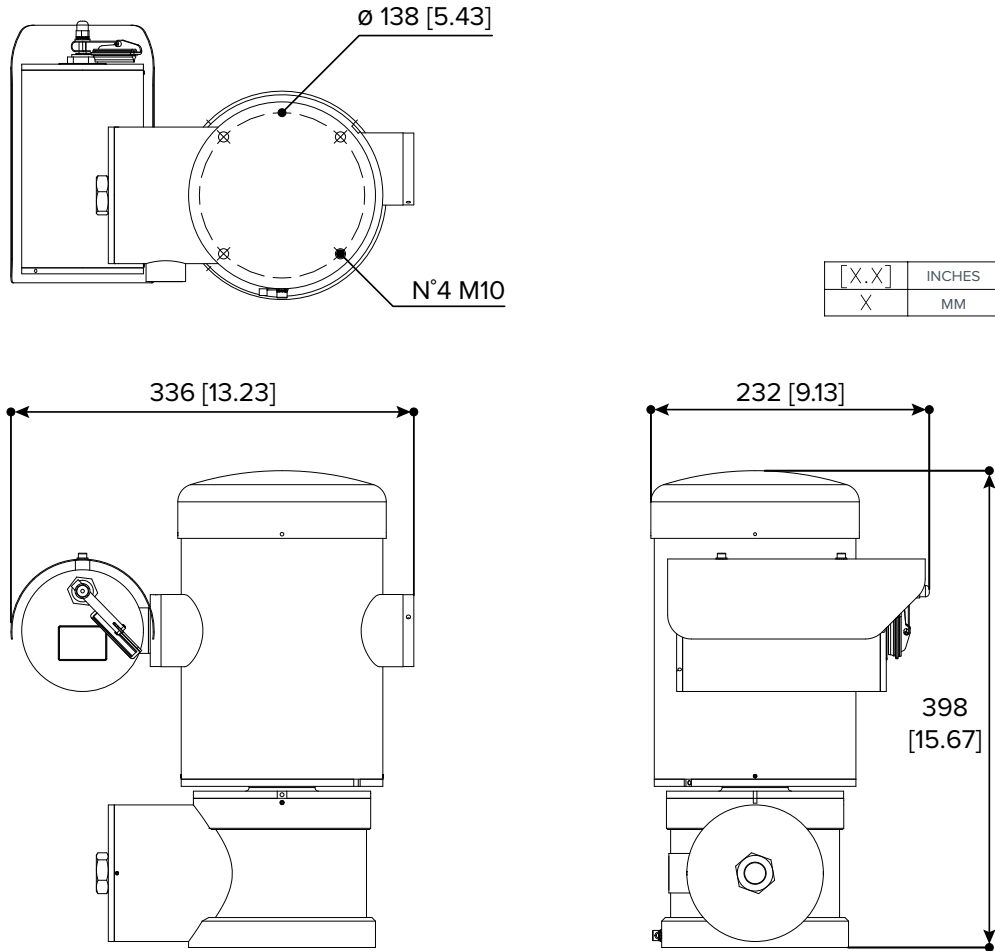

# Ordering Information

	MP	WDR	LightCatcher Technology	Lens	Power Supply	Analytics	HDSM SmartCodec
2.0C-H5EXPTZ-A0-BO30	2.0	✓	✓	4.3 - 129 mm	230 VAC	✓	✓
2.0C-H5EXPTZ-B0-BO30	2.0	✓	✓	4.3 - 129 mm	24 VAC	✓	✓
2.0C-H5EXPTZ-C0-BO30	2.0	✓	✓	4.3 - 129 mm	120 VAC	✓	✓

# Mounting Accessories

AVGEX-MPXWBA		Wall bracket for use with H5EX PTZ cameras. AISI 316L stainless steel.
AVGEX-MPXCOL		Pole mount adapter for use with AVGEX-MBXMP or H5EX PTZ cameras. For pole diameters from 110 mm (4.3") to 150 mm (5.9"). Max load 50 kg (110 lb). AISI 316L stainless steel.
AVGEX-MPXCW		Corner mount adapter for use with AVGEX-MBXMP or H5EX PTZ cameras. Max load 50 kg (110 lb). AISI 316L stainless steel.
AVGEX-MPXWBTA		Parapet or ceiling mount bracket for use with H5EX PTZ cameras. AISI 316L stainless steel.

## Cabling

AVGEX-MPX2CABLARM4	Cabling, 4m (13.1 ft), armored cable, barrier cable gland
AVGEX-MPX2CABL4	Cabling, 4m (13.1 ft), unarmored cable, barrier cable gland
AVGEX-MPX2CABLARM10	Cabling, 10m (32.8 ft), armored cable, barrier cable gland
AVGEX-MPXCABL10	Cabling, 10m (32.8 ft), unarmored cable, barrier cable gland





## Cable Glands

Type	Certification	Operating Temperature	Cable	Part Number	Diameter of the External Cable	Under Armor Cable Diameter
Barrier Cable Gland	IECEX / ATEX / EACEx	-60 °C to +135 °C	Unarmored cable	AVGEX-OCTEXB3/4P	17.8 mm – 20.0 mm	N/A
			Armored cable	AVGEX-OCTEXBA3/4P	16.8 mm – 23.9 mm	N/A
Cable Gland with Gasket	IECEX / ATEX / EACEx	-60 °C to +100 °C	Unarmored cable	AVGEX-OCTEX3/4C	13.0 mm – 20.2 mm	N/A
		-60 °C to +80 °C	Armored cable	AVGEX-OCTEXA3/4C	16.9 mm – 26.0 mm	11.1 mm – 19.7 mm
	ATEX	-40 °C to +100 °C	Unarmored cable	AVGEX-OCTEX3/4	14.0 mm – 17.0 mm	N/A
			Armored cable	AVGEX-OCTEXA3/4	18.0 mm – 23.0 mm	14.0 mm – 17.0 mm
Plug EX 3/4" NPT	IECEX / ATEX / EACEx	-100 °C to +400 °C	N/A	AVGEX-OEXPLUG3/4P	N/A	N/A
Conduit Sealing Fitting	IECEX / ATEX / c CSA us / EACEx	-60 °C to +80 °C	N/A	AVGEX-OCTEXP3/4C	N/A	N/A
Reduction 3/4" NPT to 1/2" NPT	IECEX / ATEX / EACEx	-100 °C to +400 °C	N/A	AVGEX-OCTEX1/2-3/4P	N/A	N/A

## Explosion-Proof Communication Box



Communication boxes include a 3-port RJ45 and 1 SFP port Ethernet switch and 24 VAC output for powering up to:

- 2x H5EX compact bullet cameras
- 2x H5EX bullet cameras with 2x washer pump
- 1x H5EX PTZ camera with 1x washer pump

AVGEX-MBA1S5A		Aluminum housing, 230 VAC input.
AVGEX-MBA2S5A		Aluminum housing, 24 VAC input.
AVGEX-MBA3S5A		Aluminum housing, 120 VAC input.
AVGEX-MBX1MAA		AISI 316L stainless steel housing, 230 VAC input.
AVGEX-MBX2MAA		AISI 316L stainless steel housing, 24 VAC input.
AVGEX-MBX3MAA		AISI 316L stainless steel housing, 120 VAC input.
AVGEX-MBXMP		Adapter plate for communication box to AVGEX-MPXCOW or AVGEX-MPXCW mounts. AISI 316L stainless steel housing.
AVGEX-MBXWRE		Wrench for opening communication boxes, AVGEX-MBX.

## Explosion-Proof Washer

A 10L (2.6 gal) tank with integrated manual pump and delivery up to 20m (66 ft), 24 VAC/VDC input.

AVGEX-WASEX2T4AT		ATEX certified solenoid valve.
AVGEX-WASEX2T4IN		INMETRO certified solenoid valve.
AVGEX-WASEX2T4KC		KCS certified solenoid valve.
AVGEX-WASEX2T4GOR		EAC Ex certified solenoid valve.
AVGEX-NXCOL		Pole mount adapter for use with H5EX bullet cameras or explosion protected washers. For pole diameters from 110 mm (4.3") to 150 mm (5.9"). Max load 50 kg (110 lb). AISI 316L stainless steel.
AVGEX-NXCW		Corner mount adapter for use with H5EX bullet cameras or explosion protected washers. Max load 50 kg (110 lb). AISI 316L stainless steel.